

E 833

Valvole di Non-ritorno Flusso verso il tubo
Non-return Valves Flow from Male Stud End
Rückschlagventile Strömungsrichtung vom Einschraubzapfen

ISO 1179-2 / ISO 8434-1

Filettatura: BSP cilindrica (DIN ISO 228) - Thread: BSP cyl. (DIN ISO 228) - Gewinde: BSP zyl. (DIN ISO 228)

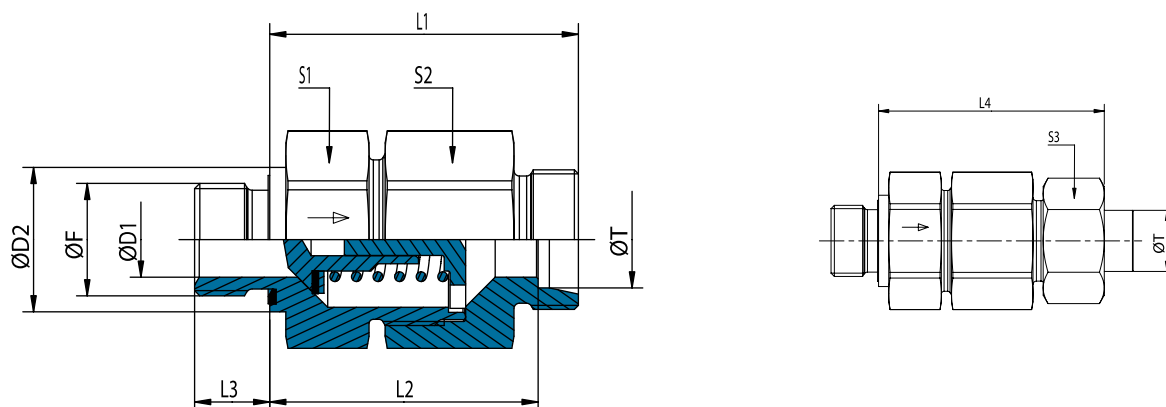

SERIE Series Reihe	Pressione Pressure Druck	Ø T	CODICE Solo Corpo Part no. Body Only Bestell-Nr. ohne Überwurfmutter	DESCRIZIONE Description Bestellzeichen	Ø F	S1	S2	S3	Ø D1	Ø D2	L1	L2	L3	L4
L	PN 400	6	E 833 8 106 000 2OM	E 833 - 106 L	G 1/8"	17	17	14	3,5	14	35	28	8	43
L	PN 400	8	E 833 8 108 000 2OM	E 833 - 108 L	G 1/4"	19	19	17	5,5	19	37	30	12	45
L	PN 400	10	E 833 8 110 000 2OM	E 833 - 110 L	G 1/4"	22	24	19	7,5	19	45,5	38,5	12	53,5
L	PN 400	12	E 833 8 112 000 2OM	E 833 - 112 L	G 3/8"	27	30	22	9,5	22	49,5	42,5	12	57,5
L	PN 315	15	E 833 8 115 000 2OM	E 833 - 115 L	G 1/2"	27	32	27	11,5	27	52,5	45,5	14	60,5
L	PN 250	18	E 833 8 118 000 2OM	E 833 - 118 L	G 1/2"	36	36	32	14	27	57,5	50	14	66,5
L	PN 250	22	E 833 8 122 000 2OM	E 833 - 122 L	G 3/4"	41	46	36	18	32	62,5	55	16	71,5
L	PN 160	28	E 833 8 128 000 2OM	E 833 - 128 L	G 1"	50	55	41	23	40	70,5	63	18	79,5
L	PN 160	35	E 833 8 135 000 2OM	E 833 - 135 L	G 1 1/4"	60	60	50	29	50	79,5	69	20	90,5
L	PN 160	42	E 833 8 142 000 2OM	E 833 - 142 L	G 1 1/2"	65	70	60	29	55	80	69	22	92
S	PN 420	6	E 833 9 106 000 2OM	E 833 - 106 S	G 1/4"	19	19	17	3,5	19	38,5	31,5	12	46,5
S	PN 420	8	E 833 9 108 000 2OM	E 833 - 108 S	G 1/4"	19	19	19	3,5	19	38,5	31,5	12	46,5
S	PN 420	10	E 833 9 110 000 2OM	E 833 - 110 S	G 3/8"	22	24	22	5,5	22	45,5	38	12	54,5
S	PN 420	12	E 833 9 112 000 2OM	E 833 - 112 S	G 3/8"	24	27	24	7,5	22	48,5	41	12	57,5
S	PN 420	14	E 833 9 114 000 2OM	E 833 - 114 S	G 1/2"	27	32	27	9,5	27	52,5	44,5	14	62,5
S	PN 420	16	E 833 9 116 000 2OM	E 833 - 116 S	G 1/2"	32	36	30	11,5	27	56,5	48	14	66,5
S	PN 250	20	E 833 9 120 000 2OM	E 833 - 120 S	G 3/4"	38	41	36	15	32	62,5	52	16	73,5
S	PN 250	25	E 833 9 125 000 2OM	E 833 - 125 S	G 1"	46	50	46	19	40	66,5	54,5	18	78,5
S	PN 250	30	E 833 9 130 000 2OM	E 833 - 130 S	G 1 1/4"	55	60	50	24	50	77,5	64	20	90,5
S	PN 250	38	E 833 9 138 000 2OM	E 833 - 138 S	G 1 1/2"	65	70	60	29	55	85,5	69,5	22	100,5

Raccordi completi finale -Z al posto di -2OM

[Articoli di basso consumo su richiesta](#)

Complete fittings ending with -Z as final code, instead of -2OM

[Slow moving articles available on request](#)

Bei Komplettverschraubungen Code -Z an Stelle von -2OM verwenden

[Artikel mit geringem Verbrauch \(auf Anfrage\)](#)

Pressione di apertura 1 bar. Su richiesta con apertura a: 0,2 - 0,5 - 2 - 3 - 5 bar.

Temperature di utilizzo senza riduzione di pressione con guarnizioni e O-Ring in NBR: da -35° a +100°C.

Opening pressure 1 bar. On request for opening pressure: 0,2 - 0,5 - 2 - 3 - 5 bar.

Permissible working temperatures without reductions in pressure for captive seals and O-Rings in NBR: -35° to +100°C.

Öffnungsdruck 1 bar. Auf Anfrage für Öffnungsdruck: 0,2 - 0,5 - 2 - 3 - 5 bar.

Zulässige Betriebstemperatur ohne Druckabschläge für Dichtungen und O-Ringe aus NBR: -35° bis +100°C.

E 831 - E 832 - E 833

Valvole di Non-ritorno: molle e coppie di serraggio

Non-return Valves: springs and tightening torques

Rückschlagventile: Federn und Anzugsdrehmomente

CODICE MOLLA Spring Part. Nr. Federn Bestell-Nr.	PRESSIONE BAR Pressure bar Druck bar	SERIE Serie Reihe	Ø T	CORPO VALVOLA NM Valve body Nm Anziehdrehmoment Ventilkörper Nm	Ø PASSAGGIO [mm] Ø Passage [mm] Ø Durchfluss [mm]	APERTURA [mm] Opening [mm] Öffnung [mm]
E9308006010	1	{ L S S	06	24	3,5	1,3
E9308006002	0,2					
E9308006005	0,5					
E9308006020	2					
E9308006030	3					
E9308006050	5					
E9308008010	1	{ L S	08	35	5,5	2
E9308008002	0,2					
E9308008005	0,5					
E9308008020	2					
E9308008030	3					
E9308008050	5					
E9308010010	1	{ L S	10	60	7,5	2,5
E9308010002	0,2					
E9308010005	0,5					
E9308010020	2					
E9308010030	3					
E9308010050	5					
E9308012010	1	{ L S	12	90	9,5	3
E9308012002	0,2					
E9308012005	0,5					
E9308012020	2					
E9308012030	3					
E9308012050	5					
E9308015010	1	{ L S	15	130	11,5	3,5
E9308015002	0,2					
E9308015005	0,5					
E9308015020	2					
E9308015030	3					
E9308015050	5					
E9308018010	1	{ L S	18	160	14	4,5
E9308018002	0,2					
E9308018005	0,5					
E9308018020	2					
E9308018030	3					
E9308018050	5					
E9308022010	1	{ L S	22	250	18	5,5
E9308022002	0,2					
E9308022005	0,5					
E9308022020	2					
E9308022030	3					
E9308022050	5					
E9308028010	1	{ L S	28	300	23	7,5
E9308028002	0,2					
E9308028005	0,5					
E9308028020	2					
E9308028030	3					
E9308028050	5					
E9308035010	1	{ L L S	35	400	29	9,5
E9308035002	0,2					
E9308035005	0,5					
E9308035020	2					
E9308035030	3					
E9308035050	5					
E9308035010	1	{ L L S	42	600	29	9,5
E9308035002	0,2					
E9308035005	0,5					
E9308035020	2					
E9308035030	3					
E9308035050	5					

E 831 - E 832 - E 833

Valvole di Non-ritorno: Perdite di carico

Non-return Valves: Pressure loss

Rückschlagventile: Druckverlust

PORTATA Q IN L/MIN

Flow Q in L/MIN

Durchfluss Q in L/MIN

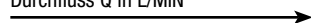

06L-06S-08S

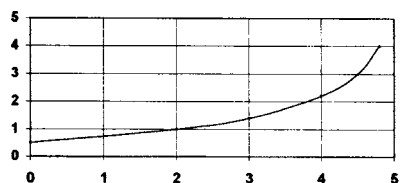

08L-10S

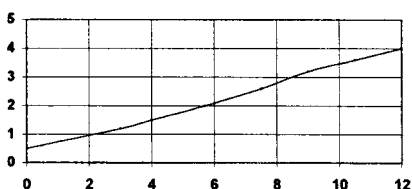

10L-12S

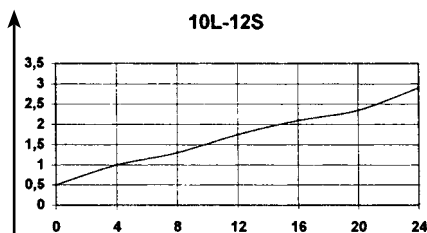

12L-14S

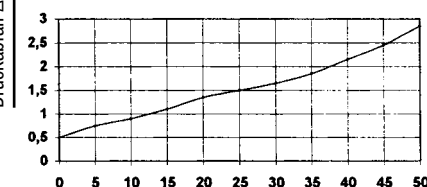

15L-16S

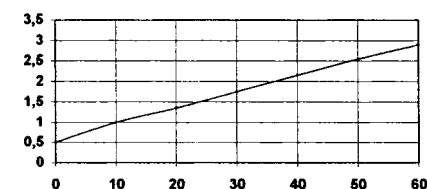

18L

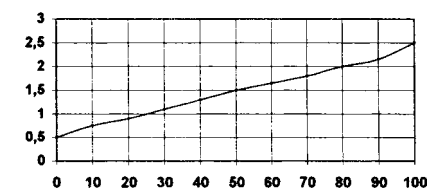

PORTATA Q IN L/MIN

Flow Q in L/MIN

Durchfluss Q in L/MIN

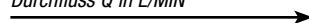

20S

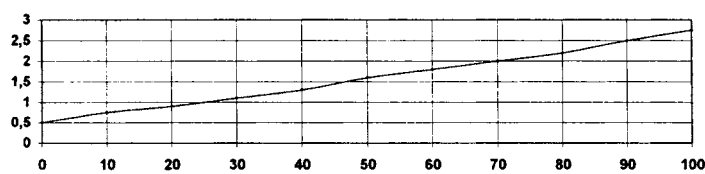

22L

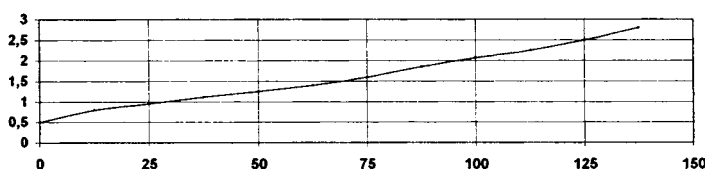

25S

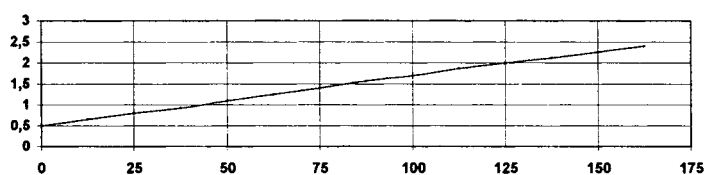

28L

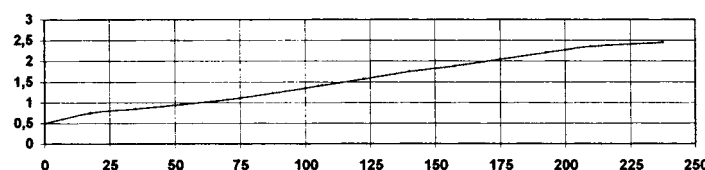

30S

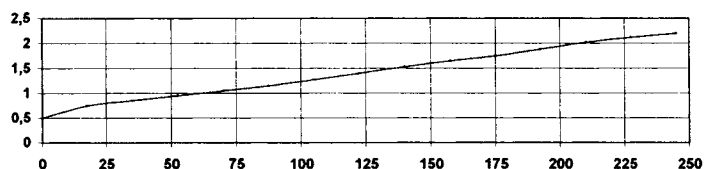

35L-42L-38S

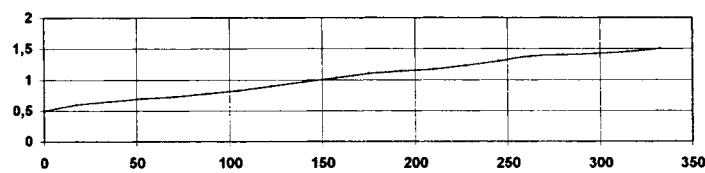

CADUTA DI PRESSIONE ΔP(BAR)

Pressure drop Δp(bar)

Druckabfall Δp(bar)

CADUTA DI PRESSIONE ΔP(BAR)

Pressure drop Δp(bar)

Druckabfall Δp(bar)